



3141 Series

The Isolator w/ Rotating Flange & Multi-Function Drain
Full Port Forged Dezincification Resistant Brass Uni-Flange Ball Valve
w/ Detachable Rotating Flange,
Multi-Function Hi-Flow Hose Drain,
Adjustable Packing Glands,
Nuts & Bolts
ASTM F1960 PEX x Rotating Flange
Max Operating Pressure: 400 WOG
Certified to NSF/ANSI 61 & 372, NSF/ANSI 14 & IAPMO ANSI Z1157
ISO 9001



ITEM#	SIZE (in)	CTN	CASE	A	B	C	D	E	F	G	H
H-31413W	3/4	1	20	0.75	3.41	2.25	2.38	0.38	3.50	1.56	2.75
H-31414W	1	1	20	1.00	3.82	2.63	3.38	0.38	3.50	1.56	2.81
HV MODELS FIT BOTH STANDARD AND HIGH VELOCITY PUMPS											
H-31413WHV	3/4	1	20	0.75	3.41	2.25	2.38	0.38	3.19	1.56	2.75
H-31414WHV	1	1	20	1.00	3.82	2.63	2.38	0.38	3.19	1.56	2.81



Designed for residential, commercial or industrial use with water, oil or gas. This approved Webstone valve is actuated by a blowout proof stem and features an adjustable packing nut. PEX end dimensions comply with ASTM F1960

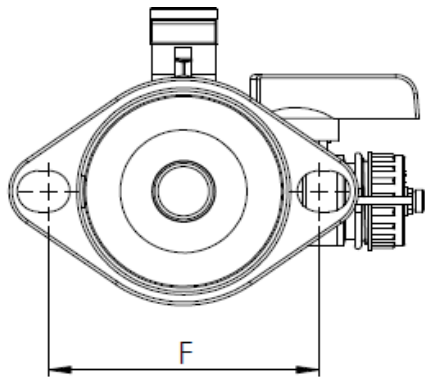
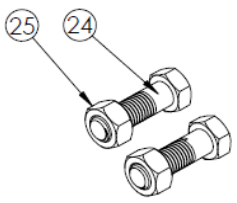
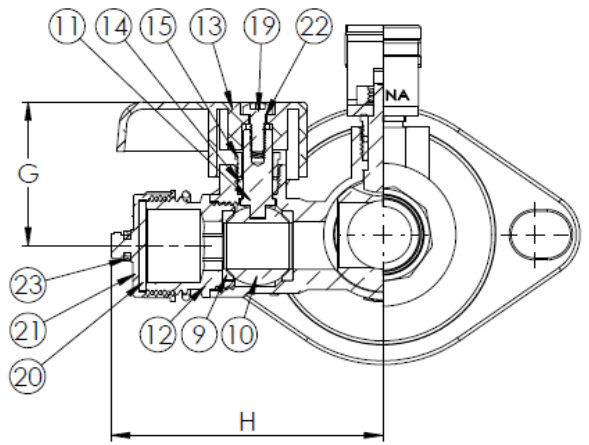
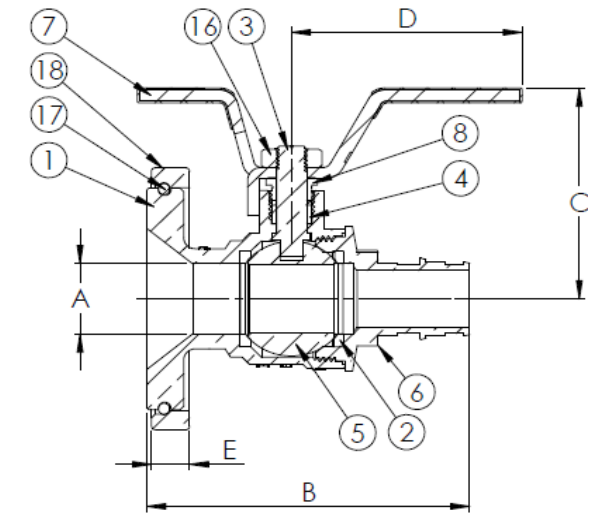

NO.	DESCRIPTION	MATERIAL
1	Body	Lead Free Brass
2	Seats	PTFE
3	Stem	Lead Free Brass
4	Packing Gland	PTFE
5	Ball	Lead Free Brass
6	End Cap	Lead Free Brass
7	Handle	Chrome Plated Steel
8	Packing Nut	Brass
9	Drain Seats	PTFE
10	Drain Ball	Lead Free Brass
11	Drain Stem	Lead Free Brass
12	Drain End Cap	Lead Free Brass
13	Drain Handle	Enamel Coated Aluminum
14	Drain Packing Gland	PTFE
15	Drain Packing Nut	Brass
16	Handle Nut	Stainless Steel
17	Retaining Ring	Stainless Steel
18	Rotating Flange	Brass
19	Drain Handle Screw	Stainless Steel
20	Drain Cap Gasket	EPDM
21	Drain Cap	Brass
22	Drain Handle Washer	Stainless Steel
23	Drain Cap Strap	PVC
24	Flange Bolts	Stainless Steel
25	Flange Nuts	Stainless Steel